

#2

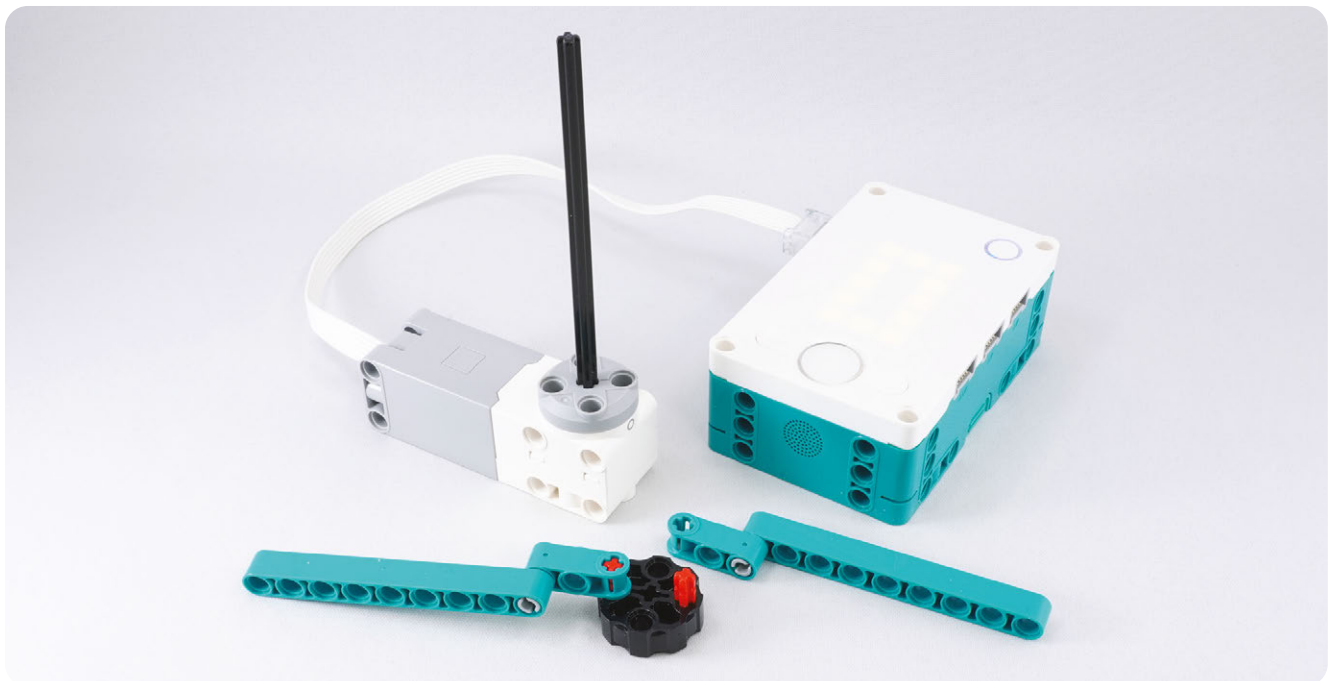

```
wenn das Programm startet
  A Geschwindigkeit auf 30 % einstellen
  A Motor starten
```

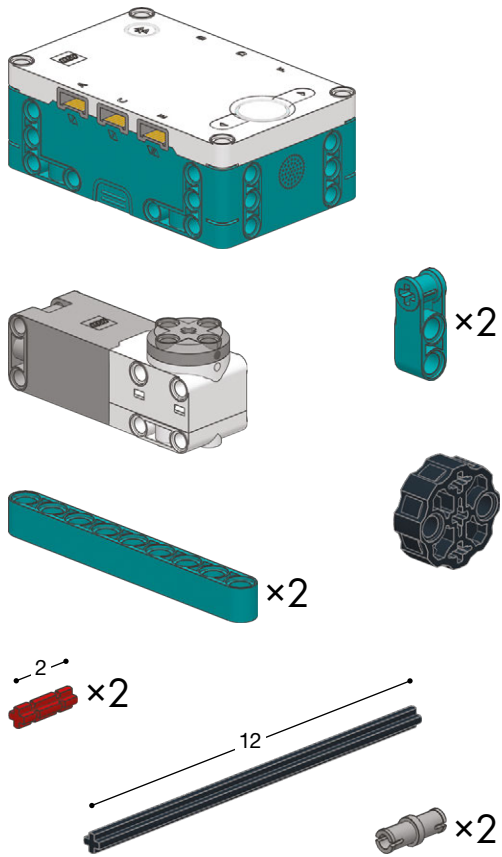
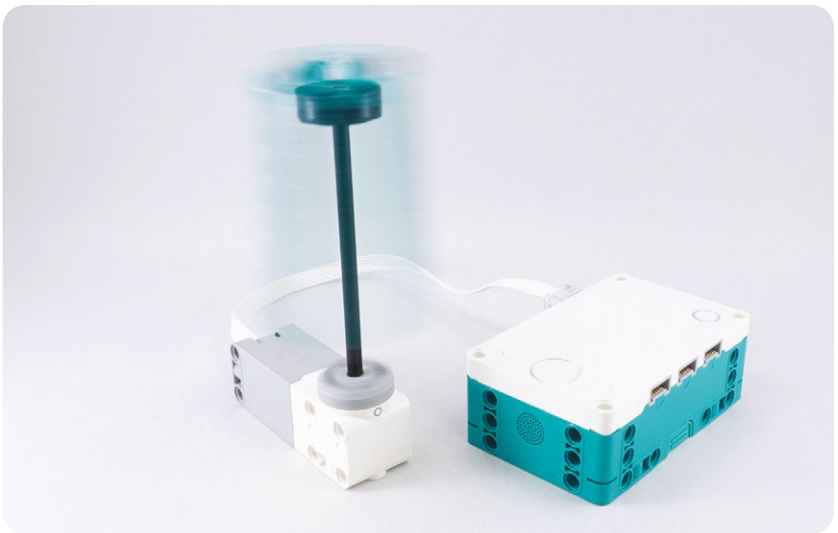

```
wenn das Programm startet
  A Geschwindigkeit auf 60 % einstellen
  A Motor starten
```

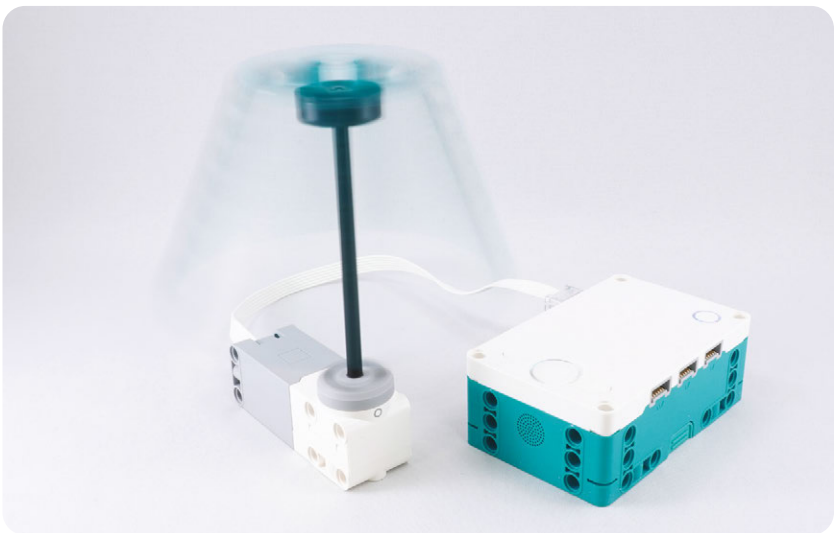

```
wenn das Programm startet
  A Geschwindigkeit auf 100 % einstellen
  A Motor starten
```

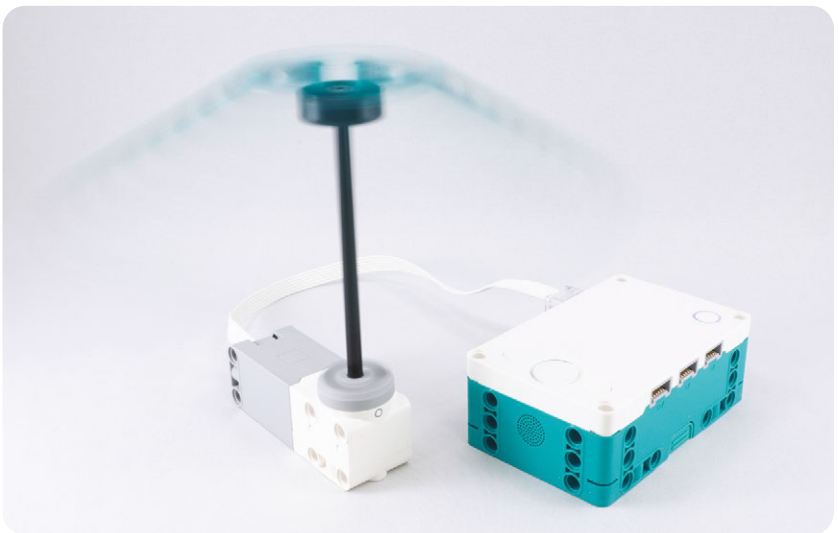

#3

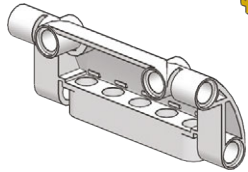
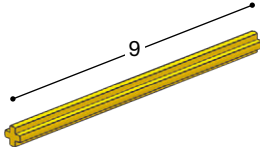
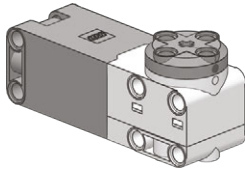
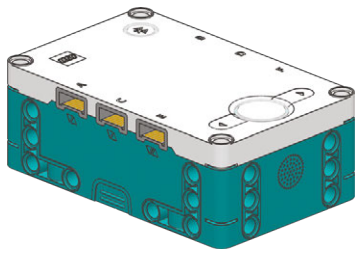

```

wenn das Programm startet
  wiederhole fortlaufend
    Motor A 90 Grad laufen lassen
    Motor A 90 Grad laufen lassen
  
```

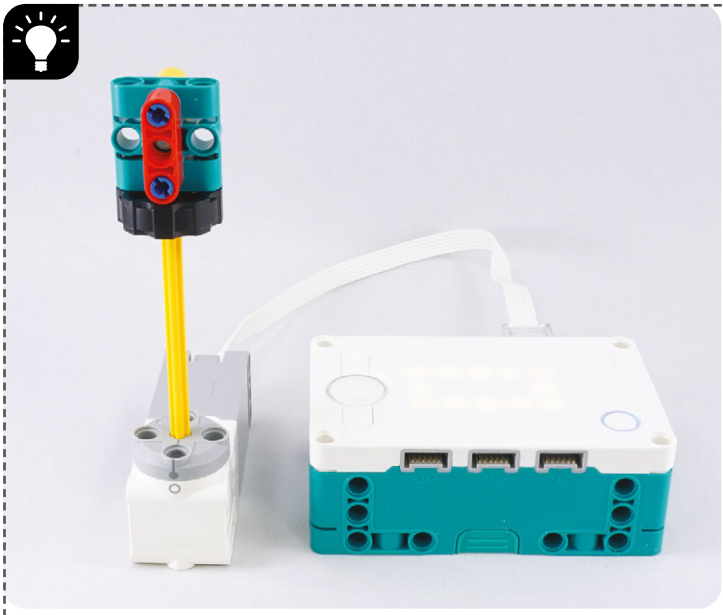

```

wenn das Programm startet
  wiederhole fortlaufend
    Motor A 120 Grad laufen lassen
    Motor A 120 Grad laufen lassen
  
```