



**Montag**



  

erledigt

kontrolliert

$637 = 6H + 3Z + 7E$ $637 = 600 + 30 + 7$	3. $830 =$ _____ $830 =$ _____	6. $284 =$ _____ $284 =$ _____
1. $428 =$ _____ $428 =$ _____	4. $706 =$ _____ $706 =$ _____	7. $381 =$ _____ $381 =$ _____
2. $842 =$ _____ $842 =$ _____	5. $531 =$ _____ $531 =$ _____	8. $184 =$ _____ $184 =$ _____

**Dienstag**



erledigt

kontrolliert

Wie heißt die Zahl?

1. $800 + 40 + 9 =$ _____	5. $33 + 900 =$ _____
2. $30 + 900 =$ _____	6. $5 + 600 =$ _____
3. $300 + 50 + 6 =$ _____	7. $500 + 1 + 10 =$ _____
4. $15 + 3 + 700 =$ _____	8. $400 + 5 + 70 =$ _____

**Mittwoch**



erledigt

kontrolliert

Berechne:

1. $480 + 20 + 400 =$ _____	2. $640 + 60 + 125 =$ _____
$620 + 80 + 13 =$ _____	$790 + 10 + 89 =$ _____
$730 + 70 + 18 =$ _____	$450 + 50 + 222 =$ _____

**Donnerstag**



erledigt

kontrolliert

Immer 1000:

1. $700 +$ _____	2. $650 +$ _____	3. $750 +$ _____
$560 +$ _____	$820 +$ _____	$380 +$ _____
$900 +$ _____	$125 +$ _____	$490 +$ _____
$987 +$ _____	$962 +$ _____	$904 +$ _____

**Freitag**





erledigt

kontrolliert

Lustige Sachaufgaben:

Stefan fährt am Wochenende zum Angeln ans Meer. Am Freitag fängt er 13 Schollen. Am Samstag angelt er 17 Schollen und 3 Schuhe. Am Sonntag fängt er 5 Schollen und 13 Schuhe. Wie viele Fische hat er insgesamt geangelt?

Stefan hat genau \_\_\_\_\_ Fische geangelt.

## Lösungen

Wochenplan: 6

Wochenthema: Das Tausenderfeld

verwendet am: \_\_\_\_\_

<b>Montag</b>	$637 = 6H + 3Z + 7E$ $637 = 600 + 30 + 7$	<b>3.</b> $830 = 8H + 3Z + 0E$ $830 = 800 + 30 + 0$	<b>6.</b> $284 = 2H + 8Z + 4E$ $284 = 200 + 80 + 4$
<b>Lösungen</b>	<b>1.</b> $428 = 4H + 2Z + 8E$ $428 = 400 + 20 + 8$	<b>4.</b> $706 = 7H + 0Z + 6E$ $706 = 700 + 0 + 6$	<b>7.</b> $381 = 3H + 8Z + 1E$ $381 = 300 + 80 + 1$
	<b>2.</b> $842 = 8H + 4Z + 2E$ $842 = 800 + 40 + 2$	<b>5.</b> $531 = 5H + 3Z + 1E$ $531 = 500 + 30 + 1$	<b>8.</b> $184 = 1H + 8Z + 4E$ $184 = 100 + 80 + 4$

<b>Dienstag</b>	Wie heißt die Zahl?		
<b>Lösungen</b>	<b>1.</b> $800 + 40 + 9 = 849$	<b>5.</b> $33 + 900 = 933$	
	<b>2.</b> $30 + 900 = 930$	<b>6.</b> $5 + 600 = 605$	
	<b>3.</b> $300 + 50 + 6 = 356$	<b>7.</b> $500 + 1 + 10 = 511$	
	<b>4.</b> $15 + 3 + 700 = 718$	<b>8.</b> $400 + 5 + 70 = 475$	

<b>Mittwoch</b>	Berechne:		
<b>Lösungen</b>	<b>1.</b> $480 + 20 + 400 = 900$	<b>2.</b> $640 + 60 + 125 = 825$	
	$620 + 80 + 13 = 713$	$790 + 10 + 89 = 889$	
	$730 + 70 + 18 = 818$	$450 + 50 + 222 = 722$	

<b>Donnerstag</b>	Immer 1000:		
<b>Lösungen</b>	<b>1.</b> $700 + 300$	<b>2.</b> $650 + 350$	<b>3.</b> $750 + 250$
	$560 + 440$	$820 + 180$	$380 + 620$
	$900 + 100$	$125 + 875$	$490 + 510$
	$987 + 13$	$962 + 38$	$904 + 96$

<b>Freitag</b>	Lustige Sachaufgaben:
<b>Lösungen</b>	<p>Stefan fährt am Wochenende zum Angeln ans Meer. Am Freitag fängt er 13 Schollen. Am Samstag angelt er 17 Schollen und 3 Schuhe. Am Sonntag fängt er 5 Schollen und 13 Schuhe. Wie viele Fische hat er insgesamt geangelt?</p> <p>Stefan hat genau <u>35</u> Fische geangelt.</p>

**Montag**

☹️ 😐 😊

erledigt

kontrolliert

<b>1.</b>	<b>2.</b>	<b>3.</b>	<b>4.</b>	<b>5.</b>	<b>6.</b>
100	540	780	1000	850	900
25	102	555	247	320	95
45	300	205	333	55	890
31	173	13	125	602	99
39	69	103	987	431	777
74	21	97	17	27	35

**Dienstag**

☹️ 😐 😊

erledigt

kontrolliert

20, 40, 60, \_\_\_\_\_, \_\_\_\_\_, \_\_\_\_\_, \_\_\_\_\_, \_\_\_\_\_, \_\_\_\_\_, \_\_\_\_\_, \_\_\_\_\_, 240

30, 60, 90, \_\_\_\_\_, \_\_\_\_\_, \_\_\_\_\_, \_\_\_\_\_, \_\_\_\_\_, \_\_\_\_\_, \_\_\_\_\_, \_\_\_\_\_, \_\_\_\_\_, 390

15, 25, 20, 30, 25, \_\_\_\_\_, \_\_\_\_\_, \_\_\_\_\_, \_\_\_\_\_, \_\_\_\_\_, \_\_\_\_\_, \_\_\_\_\_, \_\_\_\_\_, 50

2, 4, 8, 16, \_\_\_\_\_, \_\_\_\_\_, \_\_\_\_\_, \_\_\_\_\_, \_\_\_\_\_, \_\_\_\_\_, \_\_\_\_\_, \_\_\_\_\_, \_\_\_\_\_, 512

\_\_\_\_\_, \_\_\_\_\_, \_\_\_\_\_, 81, 90, 99, \_\_\_\_\_, \_\_\_\_\_, \_\_\_\_\_, \_\_\_\_\_, \_\_\_\_\_, 135



**Mittwoch**

☹️ 😐 😊

erledigt

kontrolliert

Berechne:

1. $164 + 12 =$ _____	2. $36 + 64 =$ _____	3. $876 + 177 =$ _____
$352 + 16 =$ _____	$63 + 46 =$ _____	$909 + 99 =$ _____
$447 + 23 =$ _____	$223 + 475 =$ _____	$334 + 112 =$ _____
$771 + 16 =$ _____	$881 + 133 =$ _____	$537 + 93 =$ _____
$981 + 13 =$ _____	$818 + 331 =$ _____	$601 + 97 =$ _____
$899 + 19 =$ _____	$323 + 233 =$ _____	$425 + 319 =$ _____

**Donnerstag**

☹️ 😐 😊

erledigt

kontrolliert

<b>1.</b>	<b>2.</b>	<b>3.</b>																																				
<table border="1" style="width: 100%;"> <tr><th>V</th><th>Zahl</th><th>N</th></tr> <tr><td></td><td>210</td><td></td></tr> <tr><td></td><td>304</td><td></td></tr> <tr><td></td><td>800</td><td></td></tr> </table>	V	Zahl	N		210			304			800		<table border="1" style="width: 100%;"> <tr><th>V</th><th>Zahl</th><th>N</th></tr> <tr><td></td><td>1001</td><td></td></tr> <tr><td></td><td>999</td><td></td></tr> <tr><td></td><td>74</td><td></td></tr> </table>	V	Zahl	N		1001			999			74		<table border="1" style="width: 100%;"> <tr><th>V</th><th>Zahl</th><th>N</th></tr> <tr><td></td><td>36</td><td></td></tr> <tr><td></td><td></td><td>742</td></tr> <tr><td></td><td>1000</td><td></td></tr> </table>	V	Zahl	N		36				742		1000	
V	Zahl	N																																				
	210																																					
	304																																					
	800																																					
V	Zahl	N																																				
	1001																																					
	999																																					
	74																																					
V	Zahl	N																																				
	36																																					
		742																																				
	1000																																					



**Freitag**

☹️ 😐 😊

erledigt

kontrolliert

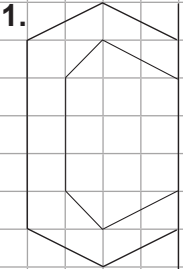
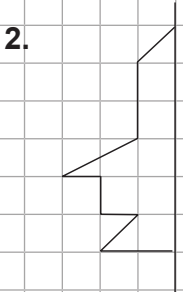
Ergänze symmetrisch:

<b>1.</b>	<b>2.</b>	<b>3.</b>
		

## Lösungen

Wochenplan: 7

Wochenthema: Rechnen um die Tausend

verwendet am: \_\_\_\_\_

**Montag**

**Lösungen**

1.	2.	3.	4.	5.	6.																																																																								
<table border="1" style="margin: auto; border-collapse: collapse;"> <tr><td colspan="2" style="text-align: center;">100</td></tr> <tr><td style="text-align: center;">25</td><td style="text-align: center;">75</td></tr> <tr><td style="text-align: center;">55</td><td style="text-align: center;">45</td></tr> <tr><td style="text-align: center;">31</td><td style="text-align: center;">69</td></tr> <tr><td style="text-align: center;">61</td><td style="text-align: center;">39</td></tr> <tr><td style="text-align: center;">74</td><td style="text-align: center;">26</td></tr> </table>	100		25	75	55	45	31	69	61	39	74	26	<table border="1" style="margin: auto; border-collapse: collapse;"> <tr><td colspan="2" style="text-align: center;">540</td></tr> <tr><td style="text-align: center;">102</td><td style="text-align: center;">438</td></tr> <tr><td style="text-align: center;">240</td><td style="text-align: center;">300</td></tr> <tr><td style="text-align: center;">173</td><td style="text-align: center;">367</td></tr> <tr><td style="text-align: center;">471</td><td style="text-align: center;">69</td></tr> <tr><td style="text-align: center;">21</td><td style="text-align: center;">519</td></tr> </table>	540		102	438	240	300	173	367	471	69	21	519	<table border="1" style="margin: auto; border-collapse: collapse;"> <tr><td colspan="2" style="text-align: center;">780</td></tr> <tr><td style="text-align: center;">555</td><td style="text-align: center;">225</td></tr> <tr><td style="text-align: center;">575</td><td style="text-align: center;">205</td></tr> <tr><td style="text-align: center;">13</td><td style="text-align: center;">767</td></tr> <tr><td style="text-align: center;">667</td><td style="text-align: center;">103</td></tr> <tr><td style="text-align: center;">97</td><td style="text-align: center;">683</td></tr> </table>	780		555	225	575	205	13	767	667	103	97	683	<table border="1" style="margin: auto; border-collapse: collapse;"> <tr><td colspan="2" style="text-align: center;">1000</td></tr> <tr><td style="text-align: center;">247</td><td style="text-align: center;">753</td></tr> <tr><td style="text-align: center;">667</td><td style="text-align: center;">333</td></tr> <tr><td style="text-align: center;">125</td><td style="text-align: center;">875</td></tr> <tr><td style="text-align: center;">13</td><td style="text-align: center;">987</td></tr> <tr><td style="text-align: center;">17</td><td style="text-align: center;">983</td></tr> </table>	1000		247	753	667	333	125	875	13	987	17	983	<table border="1" style="margin: auto; border-collapse: collapse;"> <tr><td colspan="2" style="text-align: center;">850</td></tr> <tr><td style="text-align: center;">320</td><td style="text-align: center;">530</td></tr> <tr><td style="text-align: center;">795</td><td style="text-align: center;">55</td></tr> <tr><td style="text-align: center;">602</td><td style="text-align: center;">248</td></tr> <tr><td style="text-align: center;">419</td><td style="text-align: center;">431</td></tr> <tr><td style="text-align: center;">27</td><td style="text-align: center;">823</td></tr> </table>	850		320	530	795	55	602	248	419	431	27	823	<table border="1" style="margin: auto; border-collapse: collapse;"> <tr><td colspan="2" style="text-align: center;">900</td></tr> <tr><td style="text-align: center;">95</td><td style="text-align: center;">805</td></tr> <tr><td style="text-align: center;">10</td><td style="text-align: center;">890</td></tr> <tr><td style="text-align: center;">99</td><td style="text-align: center;">801</td></tr> <tr><td style="text-align: center;">123</td><td style="text-align: center;">777</td></tr> <tr><td style="text-align: center;">35</td><td style="text-align: center;">865</td></tr> </table>	900		95	805	10	890	99	801	123	777	35	865
100																																																																													
25	75																																																																												
55	45																																																																												
31	69																																																																												
61	39																																																																												
74	26																																																																												
540																																																																													
102	438																																																																												
240	300																																																																												
173	367																																																																												
471	69																																																																												
21	519																																																																												
780																																																																													
555	225																																																																												
575	205																																																																												
13	767																																																																												
667	103																																																																												
97	683																																																																												
1000																																																																													
247	753																																																																												
667	333																																																																												
125	875																																																																												
13	987																																																																												
17	983																																																																												
850																																																																													
320	530																																																																												
795	55																																																																												
602	248																																																																												
419	431																																																																												
27	823																																																																												
900																																																																													
95	805																																																																												
10	890																																																																												
99	801																																																																												
123	777																																																																												
35	865																																																																												

**Dienstag**

**Lösungen**

20, 40, 60, 80, 100, 120, 140, 160, 180, 200, 220, 240

30, 60, 90, 120, 150, 180, 210, 240, 270, 300, 330, 360, 390

15, 25, 20, 30, 25, 35, 30, 40, 35, 45, 40, 50, 45, 55, 50

2, 4, 8, 16, 32, 64, 128, 256, 512

54, 63, 72, 81, 90, 99, 108, 117, 126, 135

**Mittwoch**

**Lösungen**

Berechne:

1. $164 + 12 = \underline{176}$	2. $36 + 64 = \underline{100}$	3. $876 + 177 = \underline{1053}$
$352 + 16 = \underline{368}$	$63 + 46 = \underline{107}$	$909 + 99 = \underline{1008}$
$447 + 23 = \underline{470}$	$223 + 475 = \underline{698}$	$334 + 112 = \underline{446}$
$771 + 16 = \underline{787}$	$881 + 133 = \underline{1014}$	$537 + 93 = \underline{630}$
$981 + 13 = \underline{994}$	$818 + 331 = \underline{1149}$	$601 + 97 = \underline{698}$
$899 + 19 = \underline{918}$	$323 + 233 = \underline{556}$	$425 + 319 = \underline{744}$

**Donnerstag**

**Lösungen**

<p>1.</p> <table border="1" style="margin: auto; border-collapse: collapse;"> <thead> <tr><th>V</th><th>Zahl</th><th>N</th></tr> </thead> <tbody> <tr><td>209</td><td>210</td><td>211</td></tr> <tr><td>303</td><td>304</td><td>305</td></tr> <tr><td>799</td><td>800</td><td>801</td></tr> </tbody> </table>	V	Zahl	N	209	210	211	303	304	305	799	800	801	<p>2.</p> <table border="1" style="margin: auto; border-collapse: collapse;"> <thead> <tr><th>V</th><th>Zahl</th><th>N</th></tr> </thead> <tbody> <tr><td>1000</td><td>1001</td><td>1002</td></tr> <tr><td>998</td><td>999</td><td>1000</td></tr> <tr><td>73</td><td>74</td><td>75</td></tr> </tbody> </table>	V	Zahl	N	1000	1001	1002	998	999	1000	73	74	75	<p>3.</p> <table border="1" style="margin: auto; border-collapse: collapse;"> <thead> <tr><th>V</th><th>Zahl</th><th>N</th></tr> </thead> <tbody> <tr><td>36</td><td>37</td><td>38</td></tr> <tr><td>740</td><td>741</td><td>742</td></tr> <tr><td>1000</td><td>1001</td><td>1002</td></tr> </tbody> </table>	V	Zahl	N	36	37	38	740	741	742	1000	1001	1002
V	Zahl	N																																				
209	210	211																																				
303	304	305																																				
799	800	801																																				
V	Zahl	N																																				
1000	1001	1002																																				
998	999	1000																																				
73	74	75																																				
V	Zahl	N																																				
36	37	38																																				
740	741	742																																				
1000	1001	1002																																				



**Freitag**

**Lösungen**

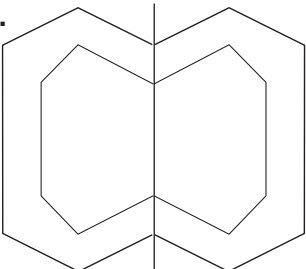
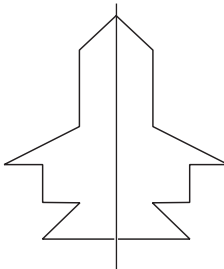
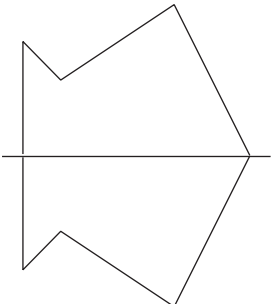
Ergänze symmetrisch:

<p>1.</p> 	<p>2.</p> 	<p>3.</p> 
---	--	---

**Montag**



  

erledigt

kontrolliert

<b>1.</b>	<b>2.</b>	<b>3.</b>
$5 + 8 = \underline{\quad}$	$15 - 6 = \underline{\quad}$	$60 + 30 = \underline{\quad}$
$6 + 9 = \underline{\quad}$	$13 - 9 = \underline{\quad}$	$40 + 20 = \underline{\quad}$
$9 + 3 = \underline{\quad}$	$11 - 5 = \underline{\quad}$	$50 + 40 = \underline{\quad}$
$7 + 8 = \underline{\quad}$	$14 - 8 = \underline{\quad}$	$10 + 30 = \underline{\quad}$

**Dienstag**



  

erledigt

kontrolliert



<b>1.</b>	<b>2.</b>	<b>3.</b>
$17 + 17 = \underline{\quad}$	$83 - 14 = \underline{\quad}$	$100 - 85 = \underline{\quad}$
$35 + 38 = \underline{\quad}$	$90 - 35 = \underline{\quad}$	$100 - 55 = \underline{\quad}$
$53 + 29 = \underline{\quad}$	$62 - 48 = \underline{\quad}$	$100 - 75 = \underline{\quad}$
$47 + 18 = \underline{\quad}$	$75 - 35 = \underline{\quad}$	$100 - 25 = \underline{\quad}$

**Mittwoch**



  

erledigt

kontrolliert

<b>1.</b>	<b>2.</b>	<b>3.</b>	
$14 + \underline{\quad} = 30$	$52 - \underline{\quad} = 40$	$\underline{\quad} + 45 = 90$	 
$26 + \underline{\quad} = 40$	$81 - \underline{\quad} = 60$	$\underline{\quad} + 52 = 100$	
$57 + \underline{\quad} = 70$	$95 - \underline{\quad} = 42$	$\underline{\quad} + 12 = 80$	

**Donnerstag**



  

erledigt

kontrolliert

<b>1.</b>	<b>2.</b>	<b>3.</b>
$26 + 17 = \underline{\quad}$	$48 + 13 = \underline{\quad}$	$53 + 11 = \underline{\quad}$
$28 + 16 = \underline{\quad}$	$48 + 14 = \underline{\quad}$	$54 + 12 = \underline{\quad}$
$30 + 15 = \underline{\quad}$	$48 + 15 = \underline{\quad}$	$55 + 13 = \underline{\quad}$
$32 + 14 = \underline{\quad}$	$48 + 16 = \underline{\quad}$	$56 + 14 = \underline{\quad}$
$34 + 13 = \underline{\quad}$	$48 + 17 = \underline{\quad}$	$57 + 15 = \underline{\quad}$
$36 + 12 = \underline{\quad}$	$48 + 18 = \underline{\quad}$	$58 + 16 = \underline{\quad}$
$38 + 11 = \underline{\quad}$	$48 + 19 = \underline{\quad}$	$59 + 17 = \underline{\quad}$

**Freitag**

erledigt

kontrolliert

Zeichne Symmetrieachsen ein:

<b>1.</b>	<b>2.</b>	<b>3.</b>
